

High-Speed Current Amplifier

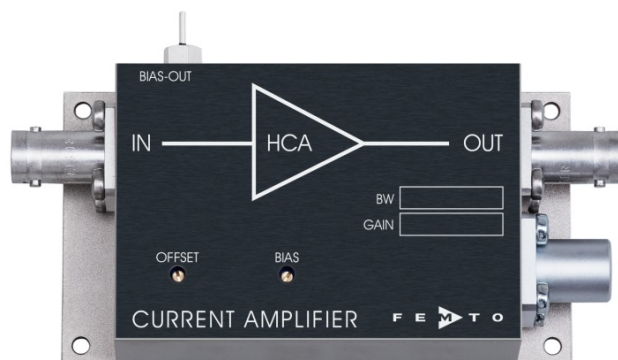

<p>Features</p>	<ul style="list-style-type: none"> • Bandwidth and Frequency Response Independent of Detector Capacitance (up to 500 pF) • Low Noise 3.5 pA/√Hz Equivalent Input Noise Current • Bandwidth DC ... 4 MHz • Transimpedance (Gain) 5 x 10⁵ V/A • Protection against ± 3.5 kV Transients 																																																										
<p>Applications</p>	<ul style="list-style-type: none"> • Photodiode and Photomultiplier Amplifier • Spectroscopy • Charge Amplifier • Ionisation Detectors • Preamplifier for Lock-Ins, A/D Converters, etc. 																																																										
<p>Specifications</p>	<table border="0"> <tr> <td>Test Conditions</td> <td colspan="2">Vs = ± 15 V, Ta = 25°C</td> </tr> <tr> <td>Gain</td> <td>Transimpedance</td> <td>5 x 10⁵ V/A (@ 50 Ω load)</td> </tr> <tr> <td></td> <td>Gain Accuracy</td> <td>± 1 %</td> </tr> <tr> <td>Frequency Response</td> <td>Lower Cut-Off Frequency</td> <td>DC</td> </tr> <tr> <td></td> <td>Upper Cut-Off Frequency (- 3 dB)</td> <td>4 MHz</td> </tr> <tr> <td></td> <td>Rise / Fall Time (10 % - 90 %)</td> <td>90 ns</td> </tr> <tr> <td></td> <td>Gain Flatness</td> <td>± 0.3 dB</td> </tr> <tr> <td>Input</td> <td>Equ. Input Noise Current</td> <td>3.5 pA/√Hz (@ 100 kHz)</td> </tr> <tr> <td></td> <td>Equ. Input Noise Voltage</td> <td>0.8 nV/√Hz (@ 100 kHz)</td> </tr> <tr> <td></td> <td>Input Bias Current</td> <td>18 μA typ.</td> </tr> <tr> <td></td> <td>Input Bias Current Drift</td> <td>0.8 nA / K</td> </tr> <tr> <td></td> <td>Offset Current Compensation</td> <td>± 6 μA adjustable by offset trimpot</td> </tr> <tr> <td></td> <td>Input Current Range</td> <td>± 3 μA (for linear amplification)</td> </tr> <tr> <td></td> <td>Input Offset Voltage</td> <td>3 mV</td> </tr> <tr> <td></td> <td>DC Input Impedance</td> <td>50 Ω (virtual) // 5 pF</td> </tr> <tr> <td>Output</td> <td>Output Voltage Range</td> <td>± 1.5 V (@ 50 Ω load) for linear operation and low harmonic distortion</td> </tr> <tr> <td></td> <td>Output Impedance</td> <td>50 Ω (terminate with 50 Ω load for best performance)</td> </tr> <tr> <td>Bias Output</td> <td>Bias Output Voltage Range</td> <td>± 12 V, adjustable by bias trimpot</td> </tr> <tr> <td></td> <td>Bias Output Impedance</td> <td>10 kΩ // 1 μF</td> </tr> </table>		Test Conditions	Vs = ± 15 V, Ta = 25°C		Gain	Transimpedance	5 x 10 ⁵ V/A (@ 50 Ω load)		Gain Accuracy	± 1 %	Frequency Response	Lower Cut-Off Frequency	DC		Upper Cut-Off Frequency (- 3 dB)	4 MHz		Rise / Fall Time (10 % - 90 %)	90 ns		Gain Flatness	± 0.3 dB	Input	Equ. Input Noise Current	3.5 pA/√Hz (@ 100 kHz)		Equ. Input Noise Voltage	0.8 nV/√Hz (@ 100 kHz)		Input Bias Current	18 μA typ.		Input Bias Current Drift	0.8 nA / K		Offset Current Compensation	± 6 μA adjustable by offset trimpot		Input Current Range	± 3 μA (for linear amplification)		Input Offset Voltage	3 mV		DC Input Impedance	50 Ω (virtual) // 5 pF	Output	Output Voltage Range	± 1.5 V (@ 50 Ω load) for linear operation and low harmonic distortion		Output Impedance	50 Ω (terminate with 50 Ω load for best performance)	Bias Output	Bias Output Voltage Range	± 12 V, adjustable by bias trimpot		Bias Output Impedance	10 kΩ // 1 μF
Test Conditions	Vs = ± 15 V, Ta = 25°C																																																										
Gain	Transimpedance	5 x 10 ⁵ V/A (@ 50 Ω load)																																																									
	Gain Accuracy	± 1 %																																																									
Frequency Response	Lower Cut-Off Frequency	DC																																																									
	Upper Cut-Off Frequency (- 3 dB)	4 MHz																																																									
	Rise / Fall Time (10 % - 90 %)	90 ns																																																									
	Gain Flatness	± 0.3 dB																																																									
Input	Equ. Input Noise Current	3.5 pA/√Hz (@ 100 kHz)																																																									
	Equ. Input Noise Voltage	0.8 nV/√Hz (@ 100 kHz)																																																									
	Input Bias Current	18 μA typ.																																																									
	Input Bias Current Drift	0.8 nA / K																																																									
	Offset Current Compensation	± 6 μA adjustable by offset trimpot																																																									
	Input Current Range	± 3 μA (for linear amplification)																																																									
	Input Offset Voltage	3 mV																																																									
	DC Input Impedance	50 Ω (virtual) // 5 pF																																																									
Output	Output Voltage Range	± 1.5 V (@ 50 Ω load) for linear operation and low harmonic distortion																																																									
	Output Impedance	50 Ω (terminate with 50 Ω load for best performance)																																																									
Bias Output	Bias Output Voltage Range	± 12 V, adjustable by bias trimpot																																																									
	Bias Output Impedance	10 kΩ // 1 μF																																																									

High-Speed Current Amplifier

Specifications (continued)

Power Supply	Supply Voltage	$\pm 15\text{ V}$
	Supply Current	$\pm 50\text{ mA typ.}$ (depends on operating conditions, recommended power supply capability minimum $\pm 150\text{ mA}$)
Case	Weight	210 g (0.5 lbs)
	Material	AlMg4.5Mn, nickel-plated
Temperature Range	Storage Temperature	$-40 \dots +100\text{ }^\circ\text{C}$
	Operating Temperature	$0 \dots +60\text{ }^\circ\text{C}$

Absolute Maximum Ratings

Input Voltage	$\pm 5\text{ V}$
Input Voltage Transient	$\pm 3.5\text{ kV}$ (pulsewidth 10 ns)
Power Supply Voltage	$\pm 22\text{ V}$

Connectors

Input	BNC
Output	BNC
Power Supply	LEMO series 1S, 3-pin fixed socket
	Pin 1: + 15V
	Pin 2: - 15V
	Pin 3: GND

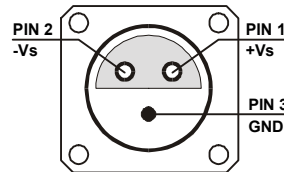

Application Diagrams

Photo Detector Biasing in Photoconductive Mode:
Best choice for high speed applications and optimum signal to noise performance.

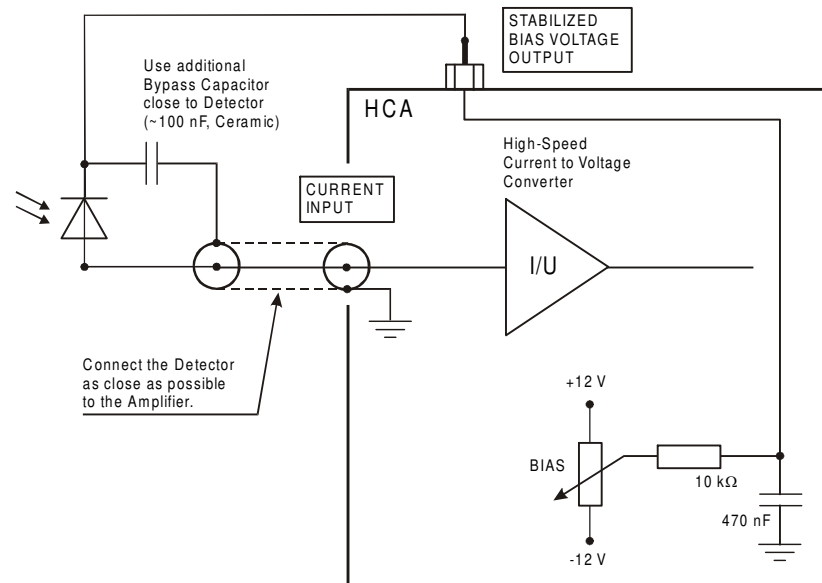

AZ01-0201-20

High-Speed Current Amplifier

Dimensions

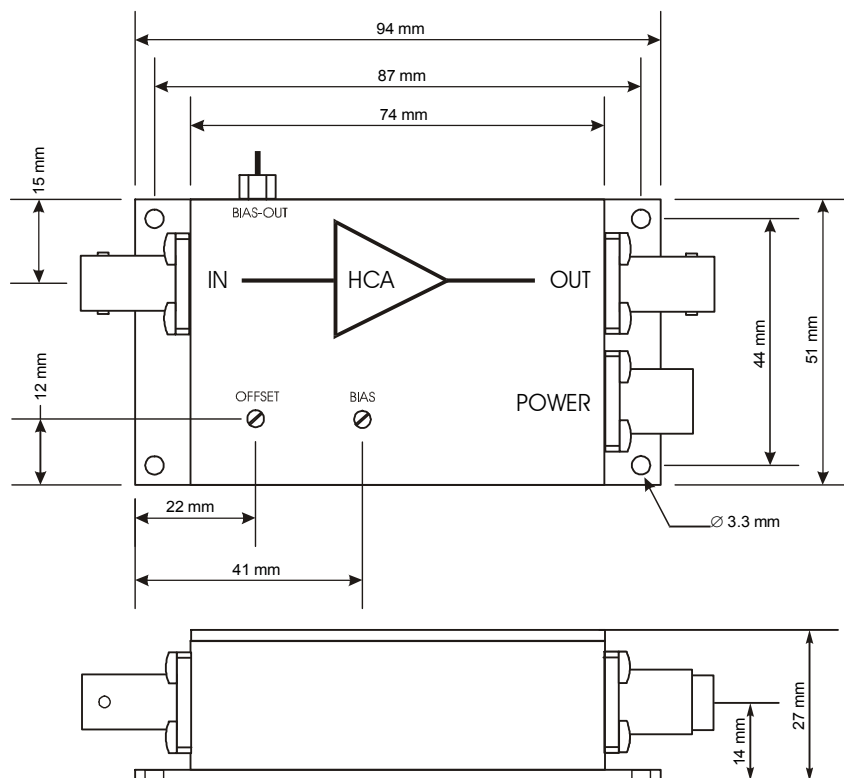

DZ01-0201-22

FEMTO Messtechnik GmbH
 Klosterstr. 64
 10179 Berlin · Germany
 Phone: +49 30 280 4711-0
 Fax: +49 30 280 4711-11
 Email: info@femto.de
 www.femto.de

Specifications are subject to change without notice. Information provided herein is believed to be accurate and reliable. However, no responsibility is assumed by FEMTO Messtechnik GmbH for its use, nor for any infringement of patents or other rights of third parties which may result from its use. No license is granted by implication or otherwise under any patent or patent rights of FEMTO Messtechnik GmbH. Product names mentioned may also be trademarks used here for identification purposes only.

© by FEMTO Messtechnik GmbH · Printed in Germany